











## Transport platform EHPM 2500 / 15

<b>EHPM 2500 / 15</b>	 <b>1500 kg</b>
	+ 1400 kg 
	+ 1300 kg 
	+ 1200 kg 
	+ 1100 kg 
	+ 1000 kg 

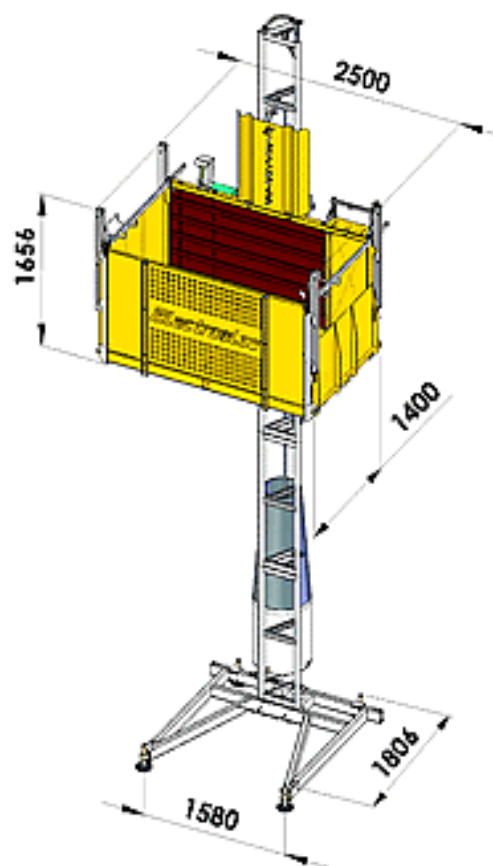

Technical Data EHPM 2500 / 15	
Max pay-load capacity	1500 kg
Lifting speed	12 m / min
Max tied height	120 m
Platform dimensions	2360 x 1311 mm
Input power range	380 / 415 V, 50 / 60 Hz, 3 Ph
Protection switch	16 A
Power of the motors	2 x 3 kW
Starting current	110 A
Minimum line power required (suggested)	10 kW

**ARISTARCHUS Ltd**

e-mail : [info@aristarchus.eu](mailto:info@aristarchus.eu)