











Transport platform EHPM 2500 / 25

EHPM2500 - 25	 2500 Kg
	+ 2400 Kg 
	+ 2300 Kg 
	+ 2200 Kg 
	+ 2100 Kg 
	+ 2000 Kg 

Technical Data EHPM 2500 / 25	
Max pay-load capacity	2500 kg
Lifting speed	12 m / min
Max tied height	120 m
Platform dimensions	3961 x 2000 mm
Input power range	380 / 415 V, 50 / 60 Hz, 3 Ph
Protection switch	32 A
Power of the motors	4 x 3 kW
Starting current	220 A
Minimum line power required (suggested)	20 kW

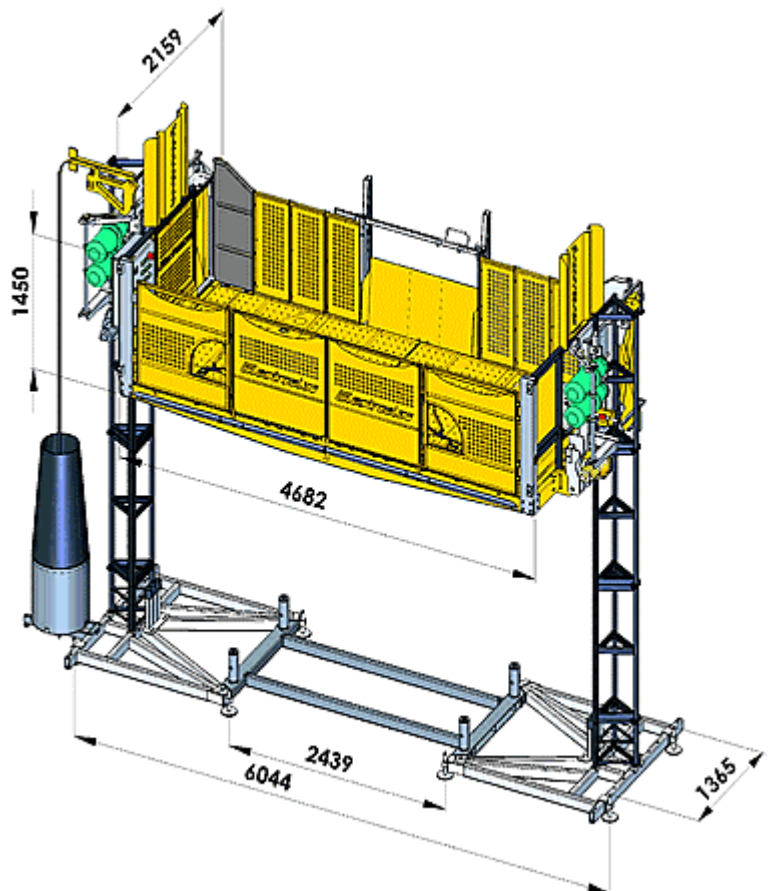

ARISTARCHUS Ltd

e-mail : info@aristarchus.eu